



Installation and usage instructions **EN**

Montage-und Gebrauchsanleitung **DE**

Instructions de montage et mode d'emploi **FR**

Instrucciones de montaje y uso **ES**

Istruzioni di montaggio e d'uso **IT**

Montage- en gebruiksinstructies **NL**

Monterings- och bruksanvisning **SV**

Monterings- og brugsvejledning **DA**

Monterings- og bruksinstruksjoner **NO**

Asennus- ja käyttöohjeet **FI**

Instruções de montagem e de uso **PT**

## **KIT SIDE** **F80**

**98661-017**

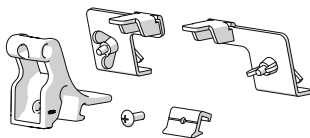

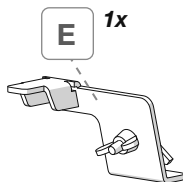
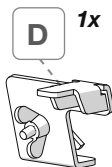
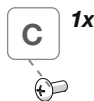
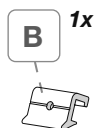
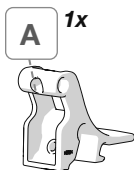
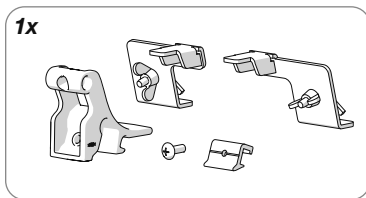

Package contents / Verpakkingsinhalt / Contenu de l'emballage / Contenido del embalaje  
 / Contenuto dell'imballo / Inhoud van de verpakking / Förpackningens innehåll / Pakkens  
 indhold / Innholdet i pakningen / Pakkauksen sisältö / Conteúdo da embalagem **p. 2**

Installation instructions / Montageanleitung / Instructions de montage /  
 Instrucciones de montaje / Istruzioni di montaggio / Montage-instructies  
 / Monteringsanvisningar / Monteringsvejledning / Monteringsinstruksjoner /  
 Aseennusohjeet / Instruções de montagem **p. 4**

Warranty / Garantie / Garantia / Garantía / Garanzia / Garantie / Garanti / Garanti /  
 Garanti / Takuu / Garantia **p. 9**



- EN** Check that nothing has been damaged or deformed during transport. In the event of doubts or questions concerning the installation, use or limitations of the product, contact the dealer.
- DE** Bitte kontrollieren Sie, dass alle Einzelteile einwandfrei sind und nicht während dem Transport beschädigt wurden. Im Zweifelsfall oder bei Fragen zur Montage, Verwendung oder zu Einschränkungen des Produkts wenden Sie sich bitte an Ihren Händler.
- FR** Contrôler le contenu du colis et vérifier qu'aucune pièce n'ait été cassée ou déformée durant le transport. En cas de doutes ou de questions relatives à l'installation, l'utilisation du produit, contactez votre concessionnaire.
- ES** Controlar que ningún detalle se haya roto o deformado durante el transporte. En caso de dudas o si tiene alguna pregunta sobre el montaje, uso y limitaciones del producto, póngase en contacto con el distribuidor.
- IT** Controllare che nessun particolare sia rotto o deformato a causa di errori di trasporto. In caso di dubbi o domande relative al montaggio, utilizzo e limiti del prodotto, contattare il rivenditore.
- NL** Controleer of er geen onderdeel zijn gebroken of vervormd als gevolg van het transport. Neem contact op met uw dealer als u vragen of opmerkingen hebt over de montage, het gebruik en de beperkingen van het product.
- SV** Kontrollera att inga delar har skadats eller deformerats under transporten. Kontakta försäljaren om du har frågor om monteringen, användningen och produktens gränser.
- DA** Kontrollér, at ingen del er ødelagt eller deformeret grundet fejl under transport. I tvivlstilfælde, eller hvis du har spørgsmål vedrørende montering eller produktets brug og begrænsninger, bedes du kontakte forhandleren.
- NO** Kontroller at ingen deler er ødelagt eller deformert som følge av feil under transporten. Hvis du er i tvil eller har spørsmål knyttet til montering, bruk eller begrensninger for produktet, ta kontakt med forhandleren.
- FI** Tarkasta, että mikään osa ei ole kuljetusvirheiden vuoksi rikkoutunut tai vääntynyt. Epäselvissä tapauksissa tai jos sinulla on tuotteen asennusta, käyttöä tai rajoituksia koskevia kysymyksiä, ota yhteys jälleenmyyjään.
- PT** Controlar que nenhuma peça tenha ficado partida ou deformada devido a erros de transporte. Em caso de dúvida ou perguntas relativas à montagem, utilização e limites do produto, contactar o revendedor.

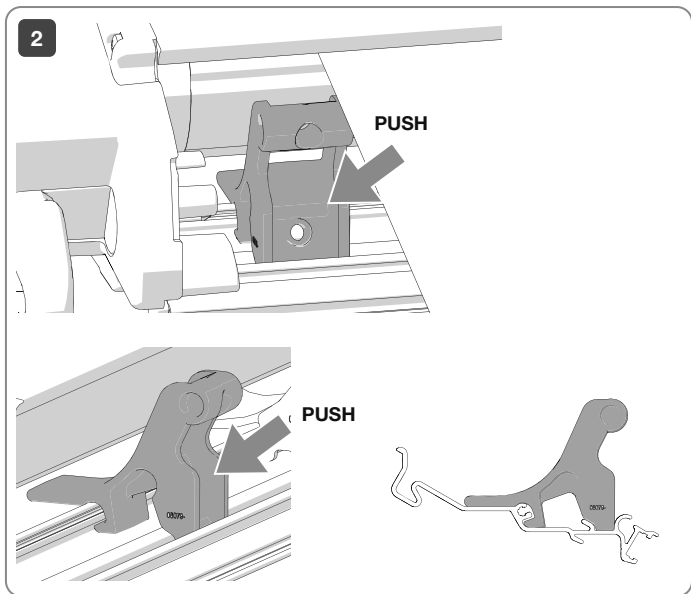
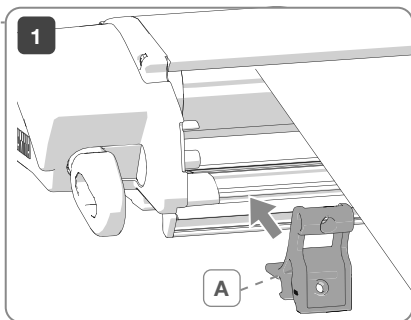
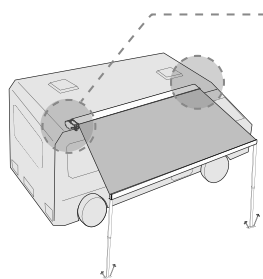

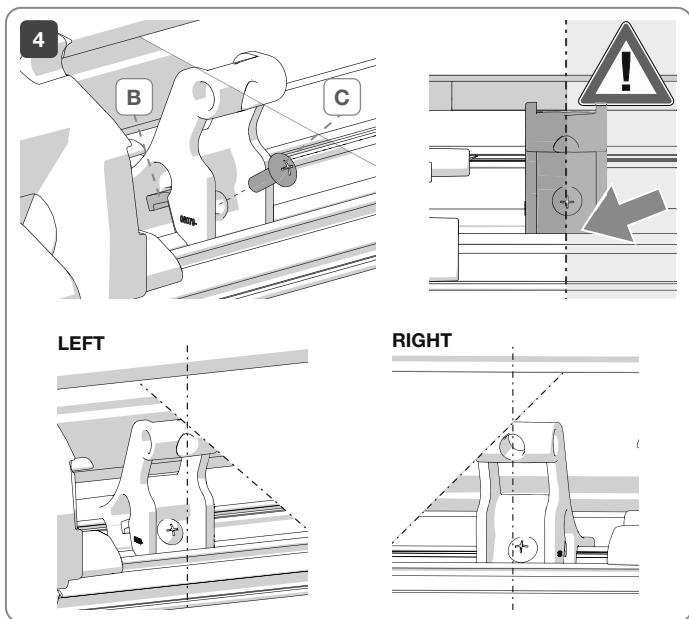
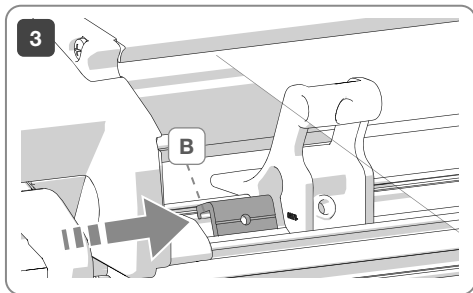

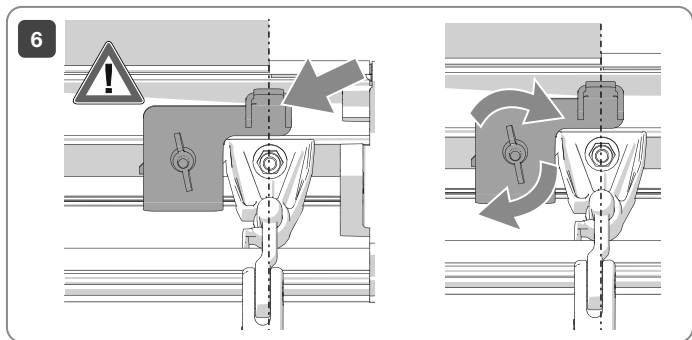
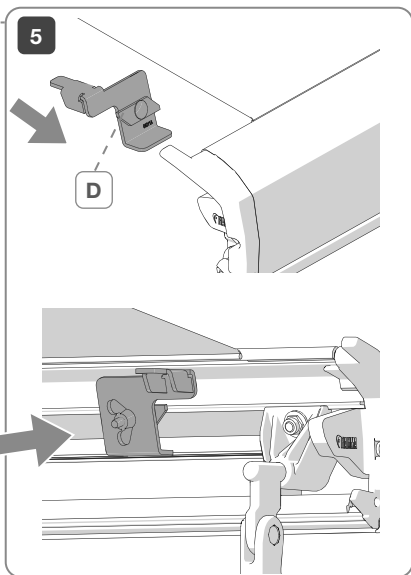
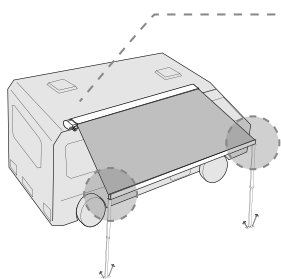

7

LEFT

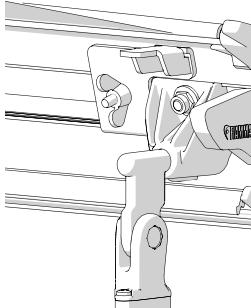

RIGHT

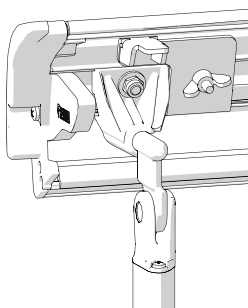

8

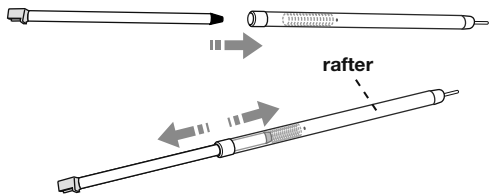
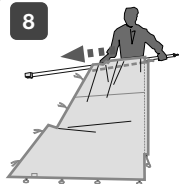

9

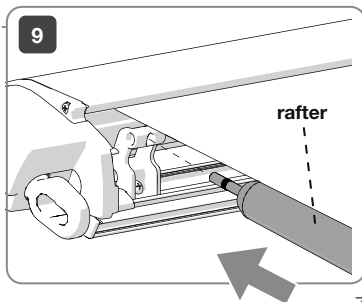
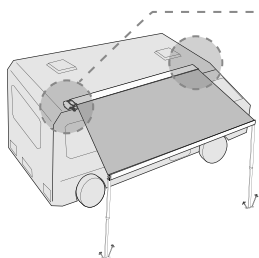

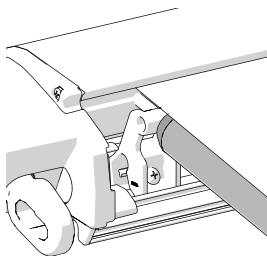
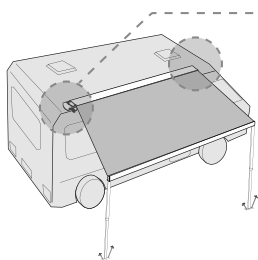
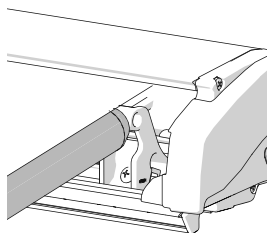
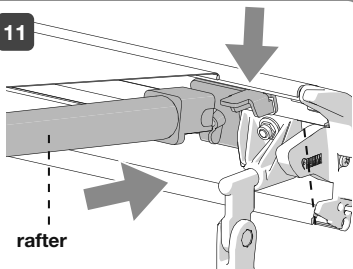
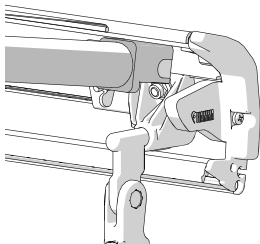
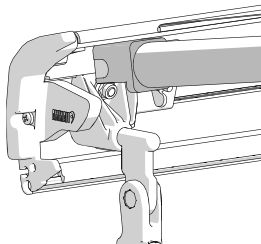
**10 LEFT****RIGHT****11****12 LEFT****RIGHT**





EN

**Warranty Fiamma**

In case of defects with regards to materials and manufacturing, the customer is entitled to the warranty in accordance with local laws and regulations of the country in which the product was purchased.

DE

**Garantie Fiamma**

Im Falle einer Mangelhaftigkeit der Ware, kann der Verbraucher unter den erforderlichen Voraussetzungen gegenüber dem Verkäufer von dem Garantieanspruch zu den festgelegten Bedingungen gemäss den lokalen Rechtsvorschriften Gebrauch machen.

FR

**Garantie Fiamma**

En cas d'un défaut de conformité du produit, le consommateur pourra faire valoir ses droits de recours en garantie selon les modalités prévues par les dispositions légales locales, pour autant que les conditions de recours soient satisfaites.

ES

**Garantía Fiamma**

En caso de fallos o defectos de material y de fabricación, el cliente puede hacer valer la garantía de acuerdo con las leyes y reglamentaciones del país en el que el producto haya sido comprado.

IT

**Garanzia Fiamma**

In caso di difetto di conformità dei beni, il consumatore potrà far valere nei confronti del venditore la garanzia secondo le modalità previste dalle disposizioni di legge locali, ove ne ricorrano i presupposti.

NL

**Fiamma garantie**

In het geval van gebrek aan overeenstemming van de goederen kan de consument zich beroepen op de wettelijke garantie ten opzichte van de verkoper, zoals vastgelegd in de plaatselijke regelgeving, indien de omstandigheden dit rechtvaardigen.

SV

**Fiamma-garanti**

Vid brister på varorna kan konsumenten åberopa garantin i enlighet med lokal lagstiftning, om omständigheterna berättigar detta.

DA

**Garanti Fiamma**

I tilfælde af defekter, hvad angår materialer og fremstilling, er forbrugeren berettiget til forhandlergaranti i henhold til lokale love og bestemmelse i det land, hvori produktet blev fremstillet.

NO

**Fiammas garanti**

I tilfelle av defekter ved varene kan forbrukeren fremme sine rettigheter i henhold til garantien overfor forhandleren, i henhold til de reglene som er fastsatt i lokale lover, der forutsetningene for dette er til stede.

FI

**Fiamma-takuu**

Jos tuotteiden vaatimustenmukaisuudessa havaitaan puutteita, kuluttaja voi vaatia myyjältä takuun mukaisia oikeuksia paikallisen lainsäädännön puitteissa, mikäli vaatimus on perusteltu.

PT

**Garantia Fiamma**

Em caso de defeito de conformidade dos bens, o consumidor poderá fazer valer, em relação ao vendedor, a garantia segundo as modalidades previstas pelas disposições de lei locais, se existirem os pressupostos para tal.







[fiamma.com](http://fiamma.com)

**Fiamma S.p.A. - Italy**

Via San Rocco, 56  
21010 Cardano al Campo (VA)

G1\_IS\_98691-031\_revA

All rights reserved.  
**Fiamma S.p.A.**  
reserves the right  
to modify at any time,  
without notice, prices, materials,  
specifications and models  
or to cease production  
of any model.